

Todas as conexões são do tipo push-in para tubos \varnothing ext. 4 mm (exceto 1334203 - G 1/8)

81532001
Sub-base individual
Fixada por 2 parafusos M4

Conexão Push-in para tubo \varnothing 4 mm

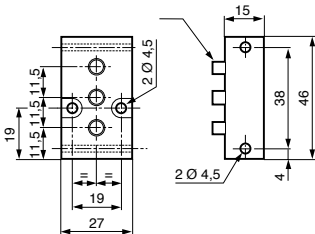

1334203
Sub-base individual
Conexões internas G 1/8
Fixada por 2 parafusos M4

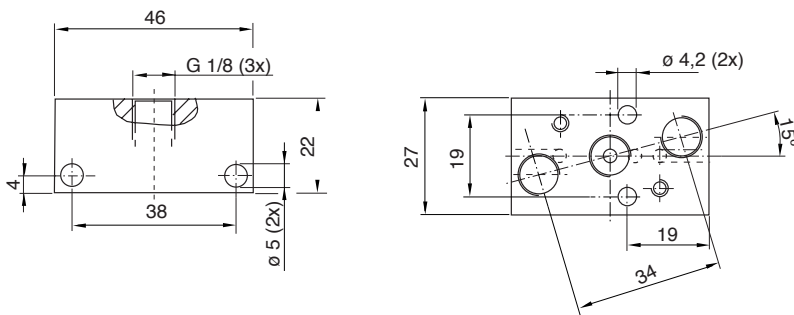

81532104
Sub-base individual
Para trilho DIN 35 mm EN 50022

81532102
Sub-base para manifold
Para trilho DIN 35 mm EN 50022

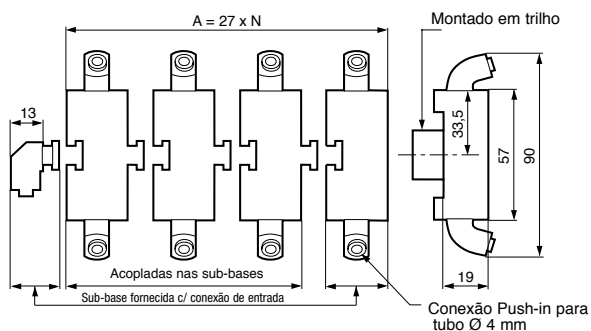
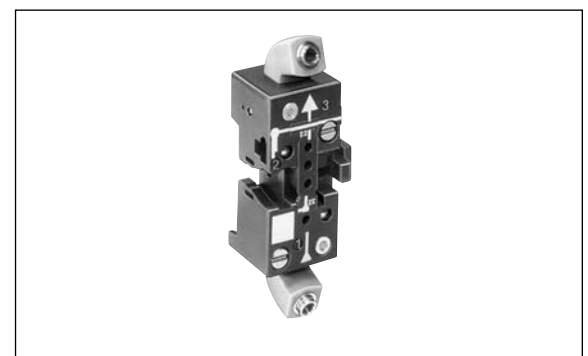
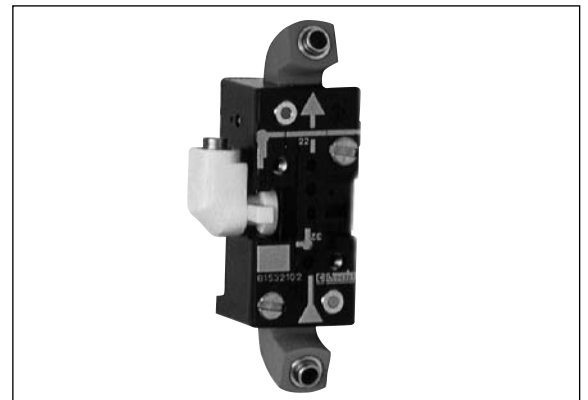

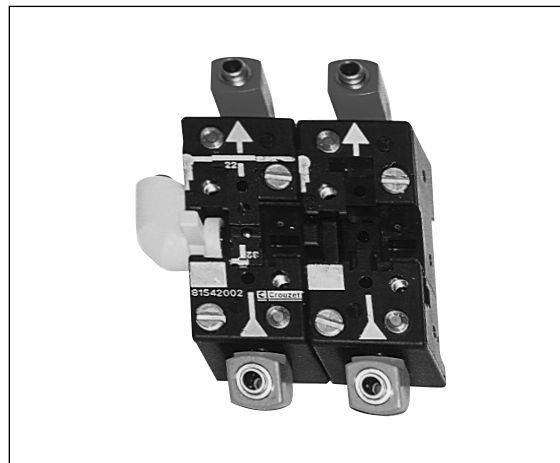
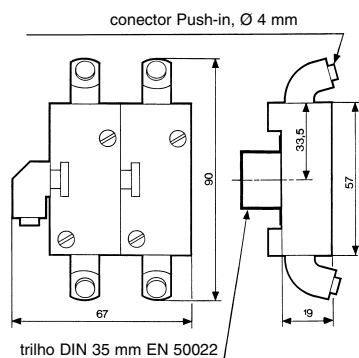
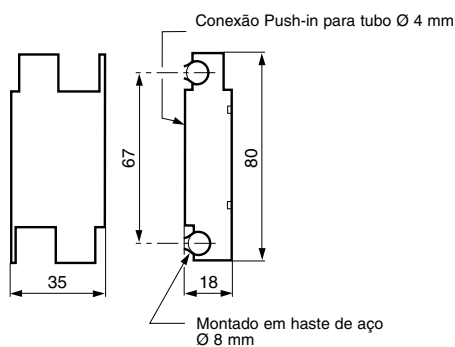
81542002
Sub-base individual.
Para trilho DIN 35 mm EN 50022

81531001
Sub-base individual
Com sistema de clips para ser montada em 2 barras de Ø 8 mm

Número de válvulas que podem ser montadas em cada sub-base

Válvulas	Sub-bases					
	81532001	1334203	81532104	81532102	81542002	81531001
81580101	1	1	1	1	-	-
81521501	1	1	1	1	-	2
81522501	1	1	1	1	-	2
81501025	1	1	1	1	-	2
81504025	1	1	1	1	-	2
81503710	1	1	1	1	-	2
81506710	1	1	1	1	-	2
81503720	1	1	1	1	-	2
81506720	1	1	1	1	-	2
81507540	1	1	1	1	-	2
81523201	-	-	-	-	1	1
81523601	-	-	-	-	1	1